

OPERATING INSTRUCTIONS & SERVICE MANUAL

4-CHANNEL RECEIVER

SANSUI QR-500

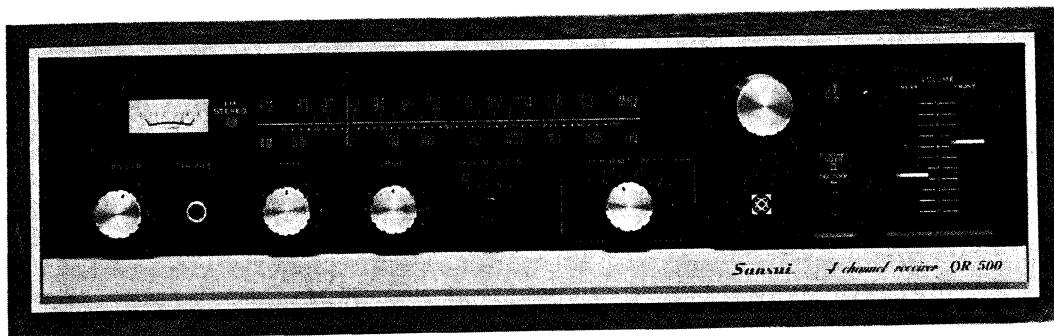

Sansui

SANSUI ELECTRIC CO., LTD.

Congratulations on joining the thousands of proud, satisfied owners of quality stereo components from Sansui.

The Sansui QR-500 4-channel receiver incorporates Sansui's unique QS Synthesizing/Decoding matrix (patents pending) that produces a multi-dimensional sound field so enthusiastically received by many audio experts as purely 'revolutionary'. An instrument that literally heralds the new age of 4-channel stereo sound reproduction, the QR-500 not only converts ordinary 2-channel stereo discs, tapes and FM broadcasts into immensely richer 4-channel stereo sound, but, working in the capacity of a decoder, restores any 2-channel material encoded from four channels to its original full-fledged 4-channel status.

To enjoy dynamic life-like 4-channel stereo sound at its best, you should be well acquainted not only with the operation of the various controls of the QR-500, but with such matters as the proper positioning of speaker systems. Read carefully the instructions contained in this booklet, and you will be better prepared to take full advantage of the advanced performance capabilities of this new instrument for years to come.

CONTENTS

SWITCHES AND CONTROLS.....	3, 4
CONNECTIONS/OPERATIONS	5, 6
TAPE DECKS/PLACEMENT OF SPEAKERS	7, 8
SIMPLE MAINTENANCE HINTS	9, 10
SPECIFICATIONS	11
CHARACTERISTICS/ACCESSORIES	12
SCHEMATIC DIAGRAM	13, 14
DISASSEMBLY PROCEDURE	15
GENERAL TROUBLESHOOTING CHART	16
PRINTED CIRCUIT BOARDS AND PARTS LIST	
.....	17, 18, 19, 20, 21, 22, 23, 24
OTHER PARTS AND THEIR POSITIONS ON CHASSIS	
.....	25, 26

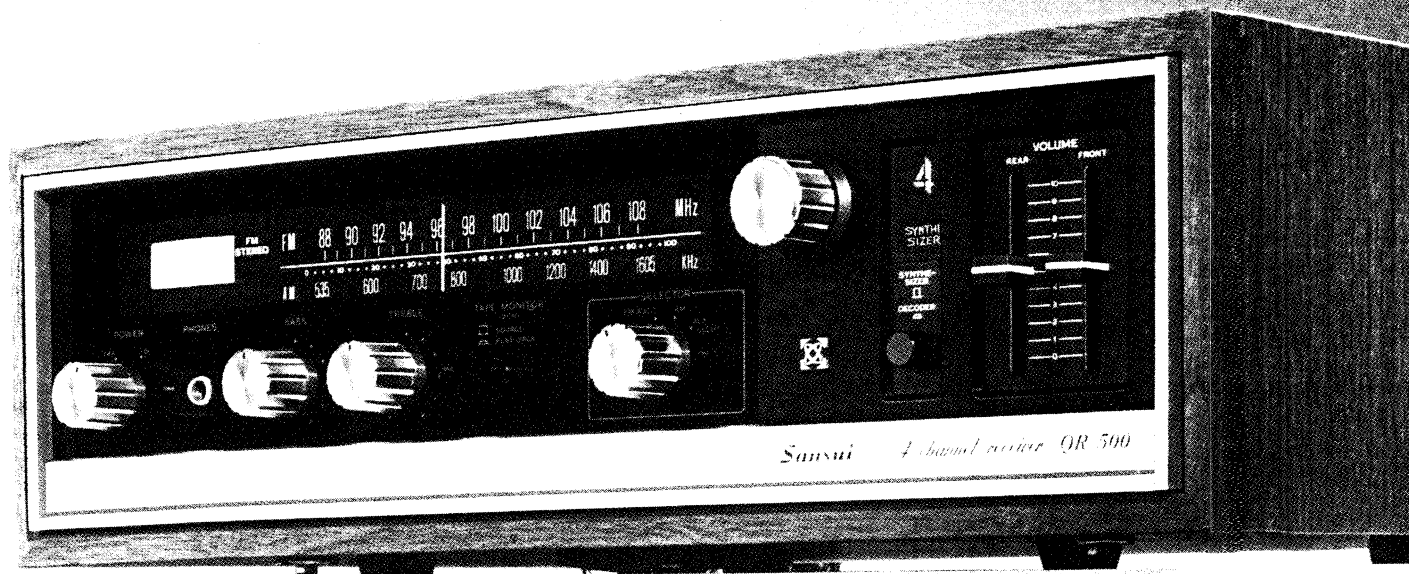

Samsui 4-band receiver OR 500

SWITCHES AND CONTROLS

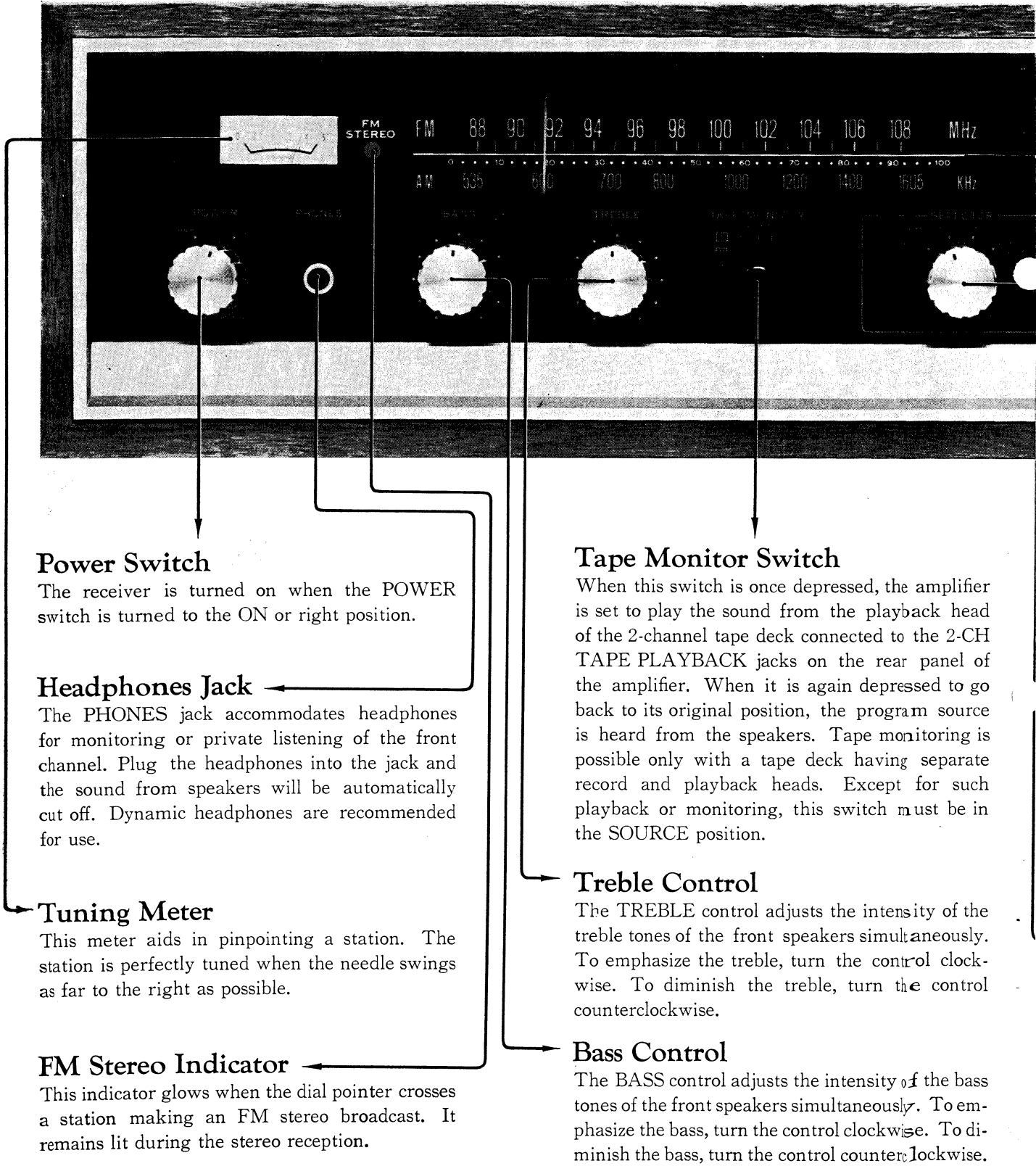

Power Switch

The receiver is turned on when the POWER switch is turned to the ON or right position.

Headphones Jack

The PHONES jack accommodates headphones for monitoring or private listening of the front channel. Plug the headphones into the jack and the sound from speakers will be automatically cut off. Dynamic headphones are recommended for use.

Tuning Meter

This meter aids in pinpointing a station. The station is perfectly tuned when the needle swings as far to the right as possible.

FM Stereo Indicator

This indicator glows when the dial pointer crosses a station making an FM stereo broadcast. It remains lit during the stereo reception.

Tape Monitor Switch

When this switch is once depressed, the amplifier is set to play the sound from the playback head of the 2-channel tape deck connected to the 2-CH TAPE PLAYBACK jacks on the rear panel of the amplifier. When it is again depressed to go back to its original position, the program source is heard from the speakers. Tape monitoring is possible only with a tape deck having separate record and playback heads. Except for such playback or monitoring, this switch must be in the SOURCE position.

Treble Control

The TREBLE control adjusts the intensity of the treble tones of the front speakers simultaneously. To emphasize the treble, turn the control clockwise. To diminish the treble, turn the control counterclockwise.

Bass Control

The BASS control adjusts the intensity of the bass tones of the front speakers simultaneously. To emphasize the bass, turn the control clockwise. To diminish the bass, turn the control counterclockwise.

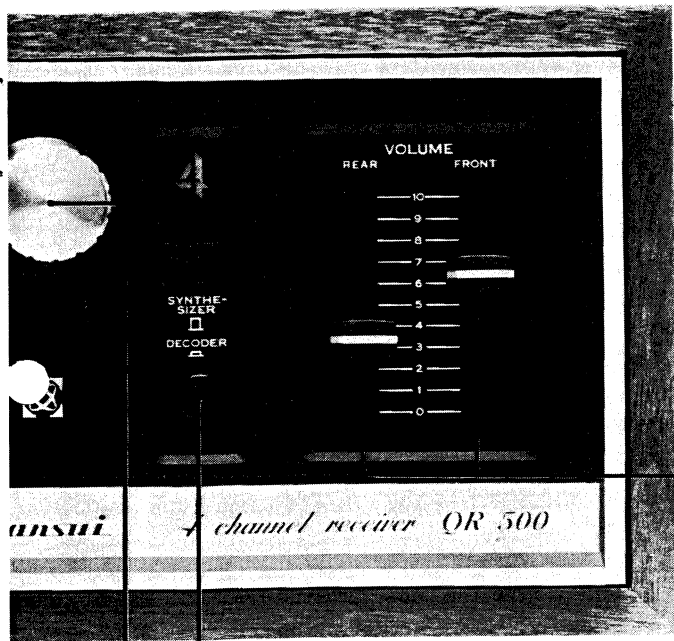

Tuning Knob

Turn the knob to find the desired station.

Dial Scales

The upper scale is for FM, the lower for AM. Find your desired station on each band by turning the TUNING knob.

Selector Switch

PHONO—Selects a record player connected to the PHONO inputs on the rear panel of the amplifier.

FM AUTO—Selects FM programs.

AM—Selects AM programs.

AUX (4CH)—Selects the output of a component, such as a 4-channel tape deck, etc., connected to the 4CH AUX jacks on the rear of the amplifier.

Volume Controls

The FRONT VOLUME control adjusts the total volume of sound from the two front speakers, the REAR VOLUME control the two rear speakers. These controls are also used to adjust the balance between the front and rear channels.

To listen to an ordinary 2-channel stereo temporarily, set the SYNTHESIZER/DECODER switch to the SYNTHESIZER position and slide the REAR VOLUME control down to the 0 position. The two-channel signals, not converted into 4 channels, will be heard from the front speakers.

Synthesizer/Decoder Switch

■ —Use this position to convert any ordinary 2-channel stereo source into 4 channels. To have the live listening experience in a concert hall, the 'Front 2-2 System' of speaker position is more effective (see page 7).

■ —With the switch in this position, the original 4-channel material which has been encoded into two channels at the recording or broadcast end is recovered for 4-channel playback. The '2-2 system' of speaker position (see page 7) is more effective to re-create a hall-ambience around the listener. It also works well with ordinary two-channel materials of pop, rock, mood music, Moog sound, etc.

CONNECTIONS/OPERATIONS

Connecting the Front and Rear Speakers

Two stereo pairs of 4- to 16-ohm speakers can be connected to the QR-500. All connections in the top row of the SPEAKERS terminals are for the front speakers, and in the bottom row for the rear speakers. The speakers on your left, front and rear, when facing the front speakers should be connected to the LEFT terminals of the QR-500, and the speakers on your right to the RIGHT terminals. The plus terminals of your speakers should be connected to the red terminals of the QR-500, and the minus or common terminals to the black terminals.

Connecting a Record Player

A record player using a magnetic cartridge can be played through the QR-500. Connect the left channel output of the record player to the LEFT PHONO input of the amplifier, and the right channel output of the record player to the RIGHT PHONO input.

FM Antennas

Indoor Dipole Antenna:

The 300-ohm folded dipole antenna (supplied) is for indoor use in urban or strong-signal areas. Connect the two leads from the dipole to the ANTENNA terminals marked FM 300Ω on the rear panel, open the dipole antenna to a full 'T' and tack it up on a wall behind the component cabinet. It is necessary to position the antenna for the best signal pickup before the antenna is permanently tacked.

Outdoor Antenna

An outdoor antenna is recommended for optimum performance in all areas. Best results will be obtained with a rotator-driven antenna specifically designed for FM. Rotate the antenna until the best pickup is obtained. If the antenna is installed near a well-traveled street, it may pickup ignition noise. In this case, move it back from the street. Connect the 300-ohm lead-in to the ANTENNA terminals marked FM 300Ω on the rear panel.

AM Antennas

The highly sensitive ferrite bar antenna, located on the rear panel of the QR-500, is usually adequate for AM reception. Pull it toward you away from the back of the chassis. In weak-signal or fringe areas, a simple outdoor antenna may suffice. Connect one end of PVC wire (supplied) to the ANTENNA terminal marked AM and hook another end outdoors as illustrated on page 6.

Listening to Discs

1. Set the SELECTOR switch of the QR-500 to the PHONO position.
2. Make appropriate settings of controls on the turntable connected to the QR-500. Start playing the disc.
3. Adjust the VOLUME controls of the QR-500 for the desired total volume of sound from the four speakers, and then for the desired balance between the front and rear channels.
4. Use the BASS and TREBLE controls according to your preference or the room acoustics.

Listening to FM or AM Programs

1. Set the SELECTOR switch to FM AUTO or AM.
2. Turn the TUNING knob to reach the desired station. The station is perfectly tuned when the needle in the TUNING meter swings as far to the right as possible. The FM STEREO indicator glows when an FM stereo broadcast is received. It remains lit during the stereo reception.
3. Adjust the VOLUME controls for the desired total volume of sound from the speakers and for the desired balance between the front and rear channels.
4. Use the BASS and TREBLE controls according to your preference or the room acoustics.

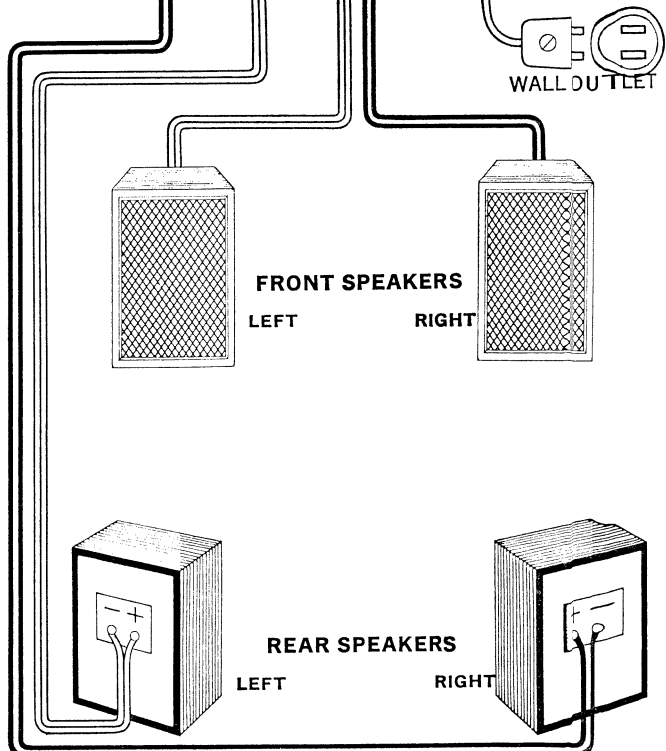
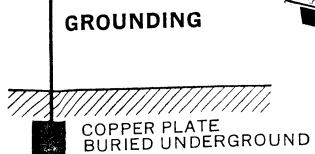
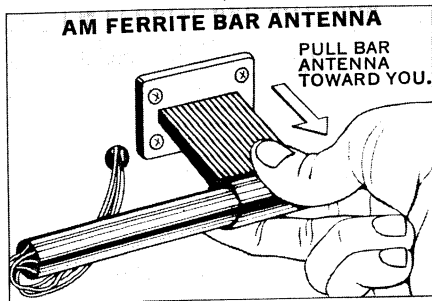
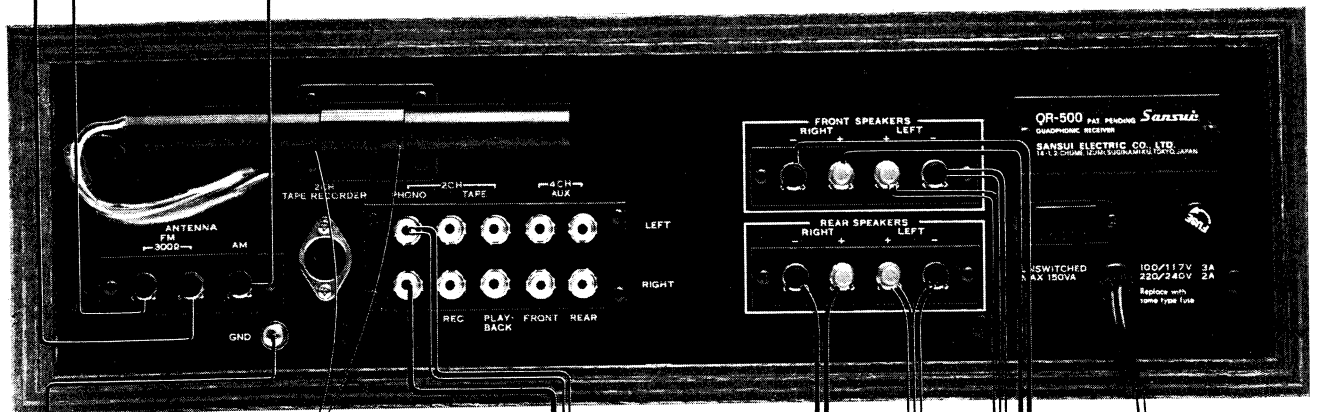
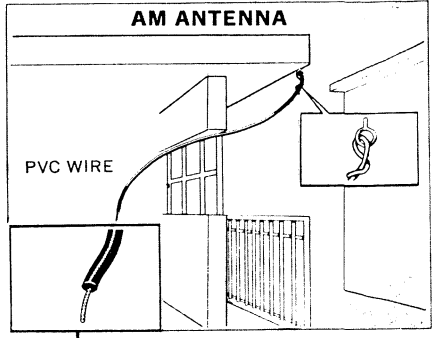
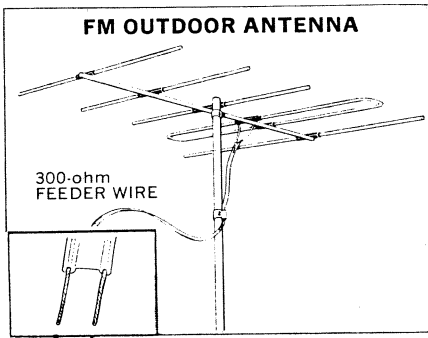
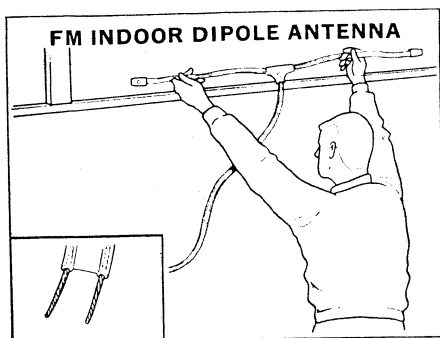

TAPE DECKS/PLACEMENT OF SPEAKERS

Connecting Tape Decks

2-Channel Tape Deck

There are two types of receptacles for connection of a 2-channel tape deck on the rear panel of the QR-500: one is for pin plugs and the other for the DIN plug.

To connect your tape deck to the pin jacks:

1. Connect the left channel output of the tape deck to the left channel jack marked 2CH TAPE PLAYBACK, and the right channel output of the deck to the right channel jack marked 2CH TAPE PLAYBACK.

2. Connect the left channel input of the tape deck to the left channel jack marked 2CH TAPE REC, and the right channel input of the deck to the right channel jack marked 2CH TAPE REC.

If you want to use the DIN connecting cord, just insert the DIN plug into the receptacle marked 2CH TAPE RECORDER on the rear panel of the QR-500.

4-Channel Tape Deck

The QR-500 is also provided with playback jacks for a 4-channel tape deck (not provided with recording jacks). Connect the outputs of the tape deck to the jacks marked 4CH (AUX) on the rear of the QR-500. Be sure connect the right and left, front and rear channels correctly as shown on page 8. The AUX input jacks, of course, can accept other components than the 4-channel tape deck.

Operating Tape Decks

Recording with a 2-Channel Tape Deck

1. Set the SELECTOR switch to the program source (PHONO, FM AUTO or AM) to be recorded.
2. Start the tape deck in the recording mode.
3. Make appropriate settings of controls on the tape deck. The recording is not affected by the controls of the QR-500.
4. Set the TAPE MONITOR switch of the QR-500 to PLAYBACK if you want to monitor the recording with the tape deck having separate heads for recording and playback.

Listening to Tapes with a 2-Channel Tape Deck

1. Depress the TAPE MONITOR switch to the PLAYBACK position.

2. Start the tape deck in the playback mode.
3. Adjust the VOLUME controls of the QR-500 for the desired volume of sound from the speakers and for the desired balance between the front and rear channels.
4. Use the BASS and TREBLE controls of the QR-500 according to your preference or the room acoustics.

Listening to Tapes with a 4-Channel Tape Deck

1. Turn the SELECTOR switch to AUX (4CH).
2. Start the tape deck in the playback mode.
3. Adjust the VOLUME controls of the QR-500 for the desired volume of sound from the speakers and for the desired balance between the front and rear channels.
4. Use the BASS and TREBLE controls of the QR-500 according to your preference or the room acoustics.

Placement of Speakers

Basically there are two ways to place two pairs of speaker systems in the 4-channel stereo:

2-2 System (Fig. 1)

This is the speaker-in-each-corner placement that is being widely accepted as the standard speaker position for 4-channel stereo. This position permits the listener to enjoy music surrounded by the four speaker systems.

Front 2-2 System (Fig. 2)

This system is designed to create a live sound field in the listening area. The sound field is equivalent to the stage of a concert hall and the listener will have the live listening experience in the hall. With the SYNTHESIZER/DECODER switch in its SYNTHESIZER position, this system is more effective.

Compatible Placement (Fig. 3)

Place the rear speaker systems as shown in Fig. 3, p. 8, and the listener will be able to enjoy both systems in the limited space available. To enjoy the '2-2 system', he should situate himself near point A, and to enjoy the 'front-2-2 system', near point B.

CONNECTING TAPE DECKS

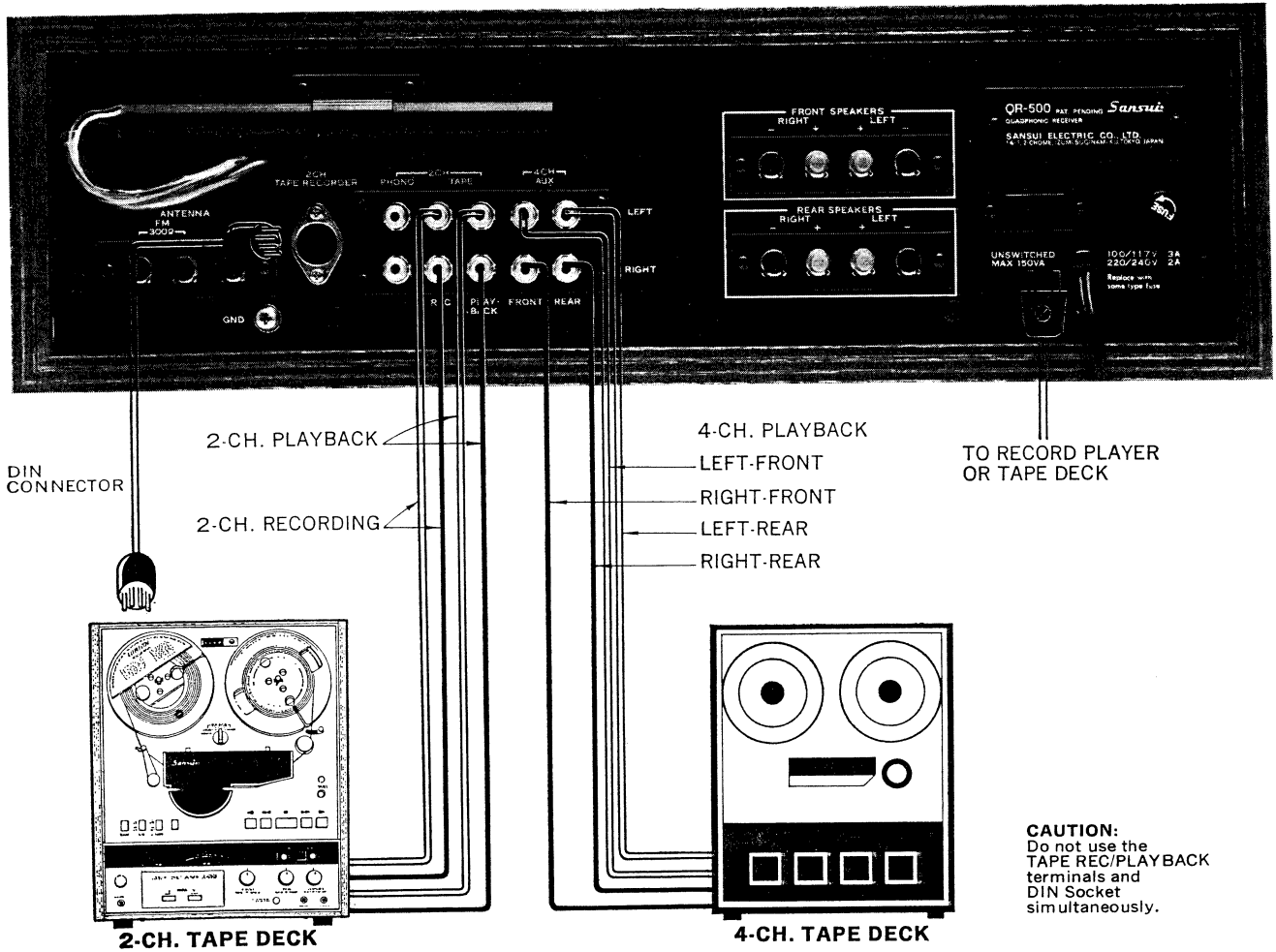

PLACEMENT OF SPEAKERS

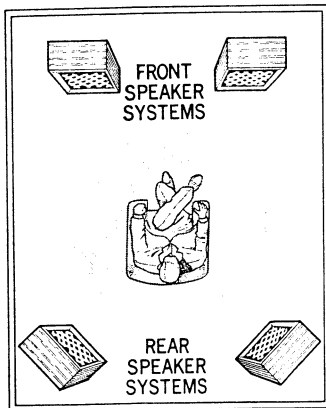

Fig. 1 2-2 SYSTEM

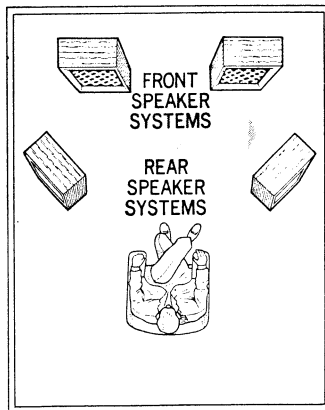

Fig. 2 FRONT 2-2 SYSTEM

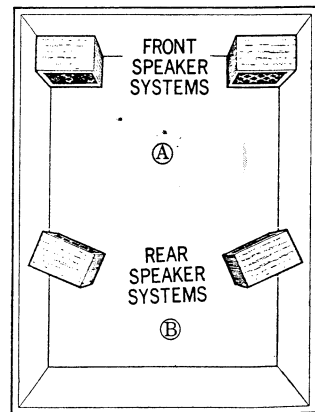

Fig. 3 COMPATIBLE PLACEMENT

SIMPLE MAINTENANCE HINTS

How to Eliminate Radio Noise On AM Programs

AM reception noise can often be eliminated by slightly changing the position of the receiver. Some noises are peculiar to a certain broadcasting frequency or a certain time of day. Such noises result from the nature of AM signals. In fringe or weak-signal areas, connect the AM antenna (supplied) to the AM ANTENNA terminal as shown on page 6.

On FM Programs

Noise on FM programs may be attributed to either insufficient antenna input or interference from other electrical appliances. In fringe or weak-signal areas, install an outdoor multi-element antenna with a rotator and position it for best signal pickup.

If it is installed near a well-traveled street, it may pick up ignition noise. In this case, move it back from the street. If still noisy, use coaxial cable (unbalanced 75-ohm) in place of the 300-ohm lead-in. Attach a matching transformer ($300\Omega \rightarrow 75\Omega$) to the antenna and then connect the center conductor to either 300 Ω terminal, and the shield to the GND terminal on the rear panel of the QR-500.

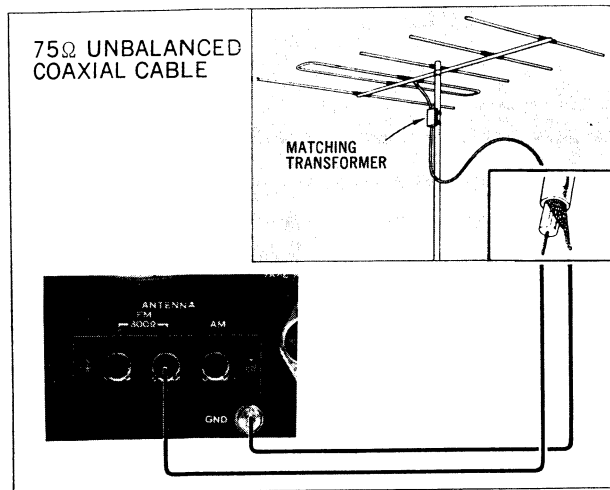

Connection of Components

Use the shielded cables to connect the audio components such as a tape deck, record player, etc. to the QR-500. These cables not only keep the distributed capacity to a minimum but are very stable against environmental changes. The use of ordinary lamp cord usually results in picking up hum. Generally, the longer the connecting cable, the more the

treble notes tend to be attenuated. It is therefore wise to keep their length below 7 feet or so.

The shielded cable is made up for use as illustrated below:

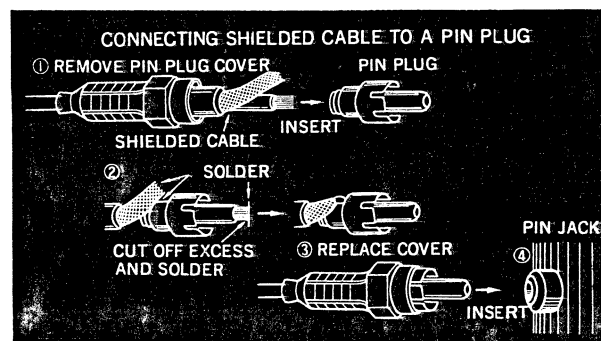

Grounding

Connect a PVC or enameled wire from the GND terminal to a grounded metal conductor such as a cold-water pipe, copper plate or carbon rod. Never connect it to a gas pipe. The grounding eliminates the possibility of hum and may reduce noise on radio programs.

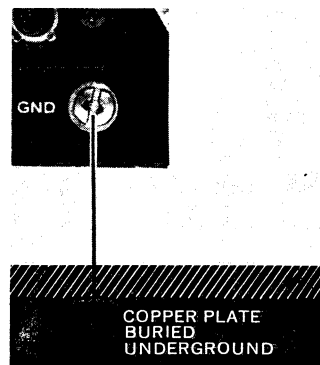

Power and Quick-Acting Fuses

If there is no sound from all speakers and the pilot light is off when the power switch is turned on, check the power fuse on the rear panel. Should the power fuse blow, remove the AC line cord and replace the blown fuse with a new glass-tubed fuse of the same capacity (3-ampere fuse required for 100-117 volt operation; 2-ampere unit for 220-240 volt operation). Please purchase the new fuse from your nearest electric goods store.

If the pilot light is on but there is no sound from both or either of the front and/or rear speaker systems, check the quick-acting fuses. If the right-front fuse, for example, should blow, the right-front

speaker system becomes dead. To reach the fuses, remove the AC line cord from its outlet and then the bonnet from the chassis. After eliminating the cause of the blowout, replace the blown fuse with a new 1.5-ampere fuse (supplied). The trouble may be attributed to the shorted output circuit or excessive large input.

If the new fuse blows when the power switch is turned on, contact your nearest Sansui dealer or Authorized Service Station.

Caution: Never use a piece of wire or a fuse of different capacity, even as a stop-gap measure, or serious danger could result.

POWER FUSE
(100/117V 3A)
(220/240V 2A)

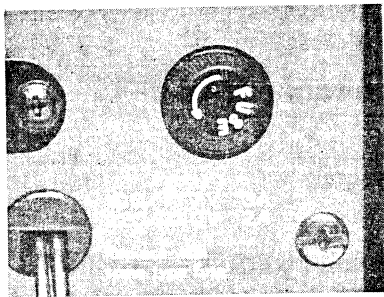

QUICK-ACTING
FUSES (1.5A x 4)

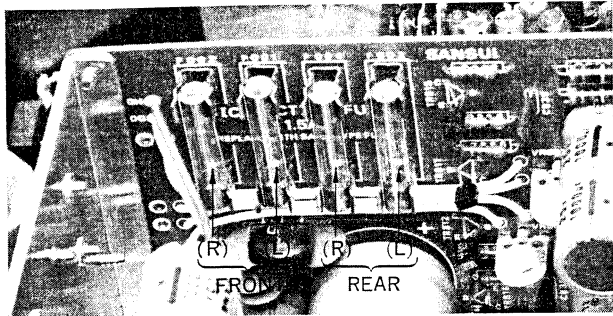

AC Outlet

The AC outlet on the rear panel is live at all times and independent of the power switch. Its maximum rating is 150VA. It is dangerous to connect a component with a bigger power requirement. Before connecting any component, make sure its power requirement does not exceed 150VA.

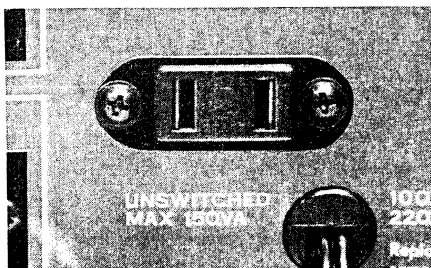

Phasing of Speakers

If the polarities (plus and minus) of the front left and right speaker systems are not identical, sound from them will lack a sense of natural sound, and also be weak in the bass range. The same applies to the polarities of the rear left and right speaker systems. Make sure the plus terminals of each speaker system have been connected to the corresponding red terminals of the QR-500, and the minus terminals of each speaker system to the corresponding black terminals. If the sound is still unnatural, the rear speakers should be changed in position and direction until natural 4-channel stereo effect is obtained.

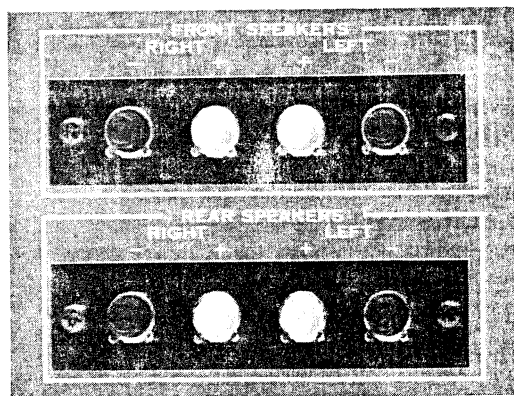

Voltage Adjustment

To reach the voltage selector, remove the two screws from the name plate on the rear panel, then remove the name plate. The voltage selector makes it possible to operate the QR-500 at the correct volt in any area. The volt has been pre-adjusted at our factory, but can be easily readjusted as follows:

1. Set the arrow on the voltage selector plug to the required volt: 100, 117, 220 or 240.
2. The power fuse should be changed, if required. For 100-117 voltage operation, a 3-ampere fuse is required. For 220-240 voltage operation, a 2-ampere fuse is required.

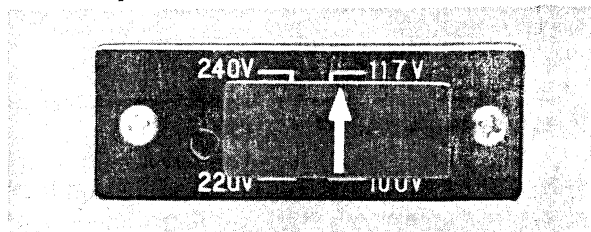

SPECIFICATIONS

AUDIO SECTION

POWER OUTPUT

MUSIC POWER (IHF): 60W at 4 ohms load
40W at 8 ohms load

CONTINUOUS POWER: 11W × 4 at 4 ohms load
8W × 4 at 8 ohms load

TOTAL HARMONIC DISTORTION:

less than 1% at rated output

INTERMODULATION DISTORTION: (60Hz: 7,000Hz=4:1
SMPTE method) less than 1%

POWER BANDWIDTH: 30 to 30,000Hz at 8 ohms load

FREQUENCY RESPONSE: (at normal listening level)
30 to 30,000Hz ±2dB

CHANNEL SEPARATION: (at 1,000Hz, rated output)
better than 50dB

HUM AND NOISE (IHF)

PHONO: less than -60dB
AUX: less than -70dB

INPUT SENSITIVITY (at rated output, 1,000Hz)

PHONO (2-CHANNEL): 3mV (50k ohms)

4-CHANNEL INPUT: 180mV (50k ohms)

TAPE MON (pin): 180mV (50k ohms)

TAPE RECORDER (DIN): 180mV (50k ohms)

RECORDING OUTPUT (at rated output, 1,000Hz)

TAPE REC (pin): 180mV

TAPE RECORDER (DIN): 30mV

LOAD IMPEDANCE: 4 to 16 ohms

DAMPING FACTOR: 50 at 8 ohms load

EQUALIZER PHONO: RIAA NF Type

TONE CONTROLS (Front channel only)

BASS: +10dB, -10dB at 50Hz

TREBLE: +10dB, -10dB at 10,000Hz

LOUDNESS: (Volume control at -30dB)
+6dB at 50Hz

TUNER SECTION

<FM>

TUNING RANGE: 88 to 108 MHz

SENSITIVITY

20dB QUIETING: 2.5μV

IHF: 5.0μV

TOTAL HARMONIC DISTORTION: less than 1%

SIGNAL TO NOISE RATIO: better than 50dB

SELECTIVITY: better than 35dB

CAPTURE RATIO: 3dB

IMAGE REJECTION: better than 45dB

IF REJECTION: better than 60dB

SPURIOUS RESPONSE REJECTION:
better than 60dB

STEREO SEPARATION: better than 30dB at 400Hz

SPURIOUS RADIATION: less than 34dB

<AM>

TUNING RANGE: 535 to 1,605kHz

SENSITIVITY: 350μV at 1,000kHz (bar antenna)

IMAGE FREQUENCY REJECTION:

better than 50dB at 1,000Hz

IF REJECTION: better than 45dB at 1,000Hz

SELECTIVITY: better than 20dB

SYNTHESIZER SECTION

INPUT LEVEL

RATED INPUT (2-channel): 180mV (50k ohms)

FREQUENCY RESPONSE

FRONT CHANNEL: 20 to 20,000Hz ±1dB

REAR CHANNEL: 20 to 20,000Hz +1dB -2dB

REAR CHANNEL PHASE SHIFT

LEFT: -90 degrees at 300Hz

RIGHT: +90 degrees at 600Hz

SEMICONDUCTORS

TRANSISTORS: 50

FET: 1

DIODES: 23

IC: 3

POWER REQUIREMENTS

POWER VOLTAGE: 100, 117, 220, 240V 50/60Hz

POWER CONSUMPTION: 60W (max. signal)

DIMENSIONS

445mm (17⁹/₁₆") W × 132mm (5¹/₈") H × 306mm (12¹/₁₆") D

WEIGHT

7.6kg (16.8 lbs.)

* Design and specifications subject to change without notice for improvements.

DISASSEMBLY PROCEDUR

REMOVING THE FRONT PANEL, WOOD CASE AND BOTTOM BOARD

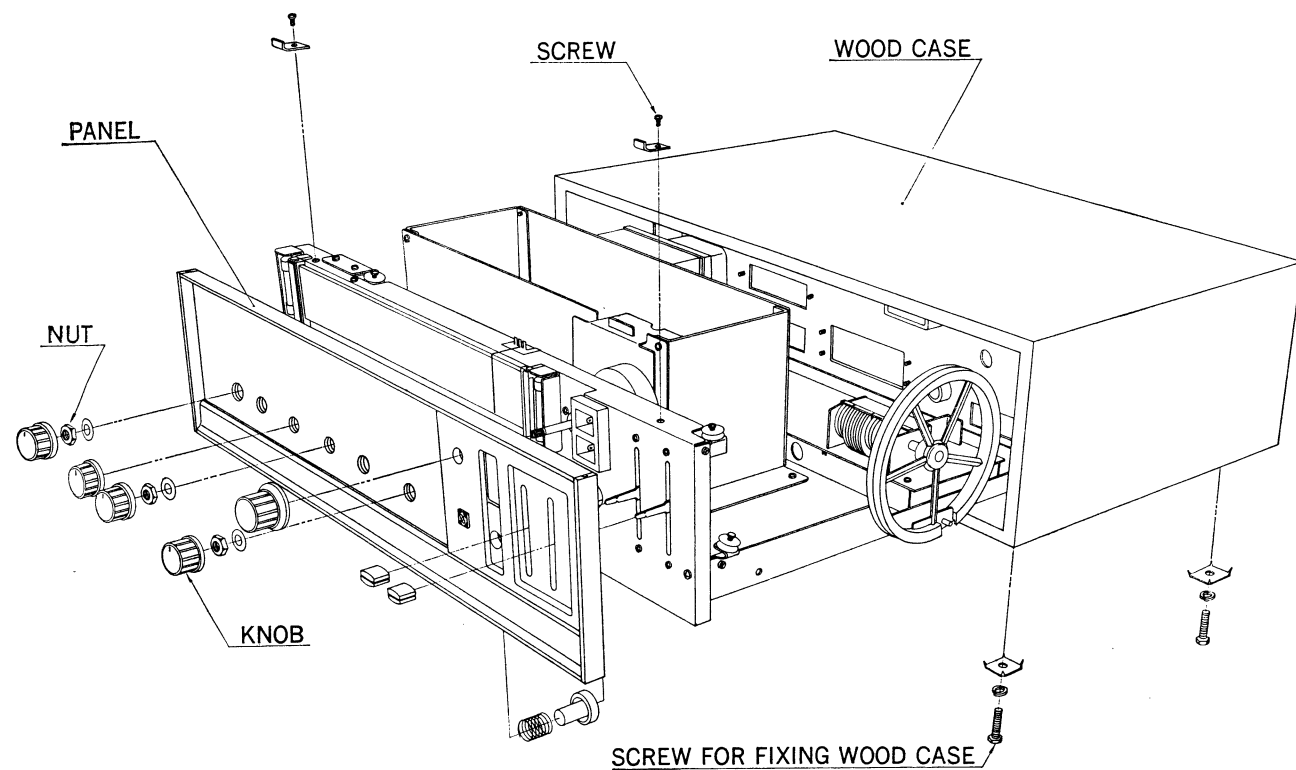

DIAL MECHANISM

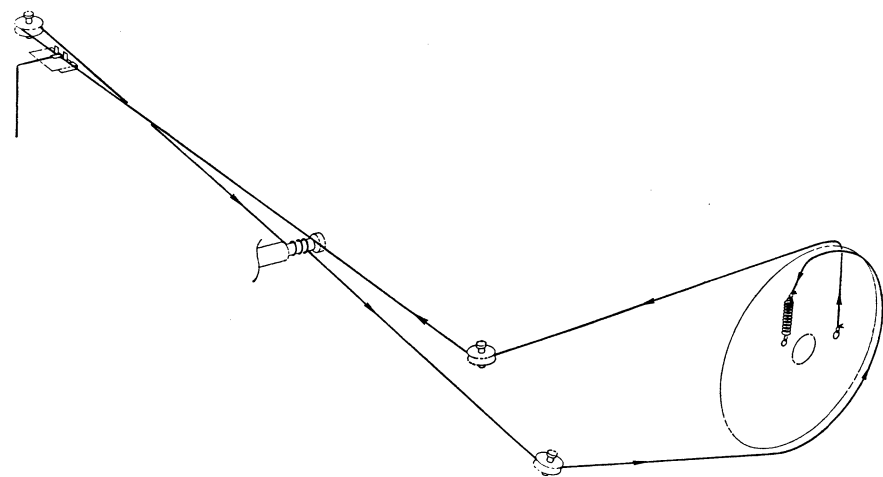

CHARACTERISTICS / ACCESSORIES

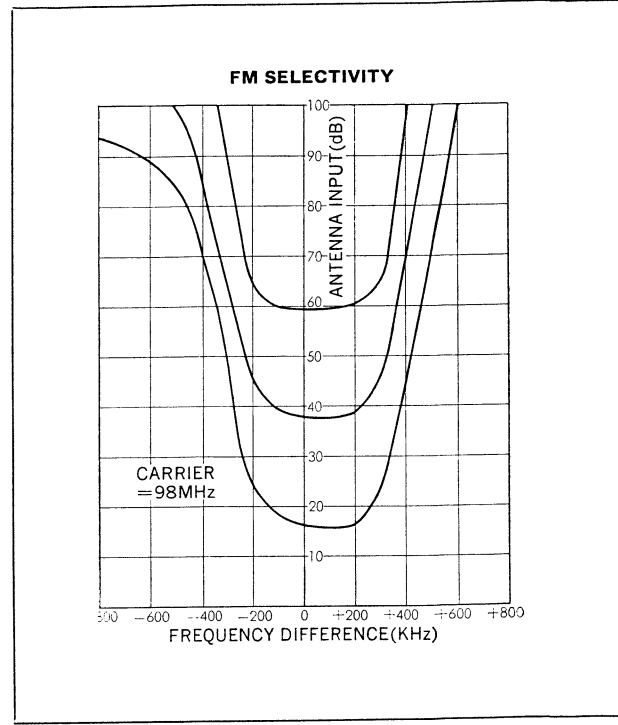
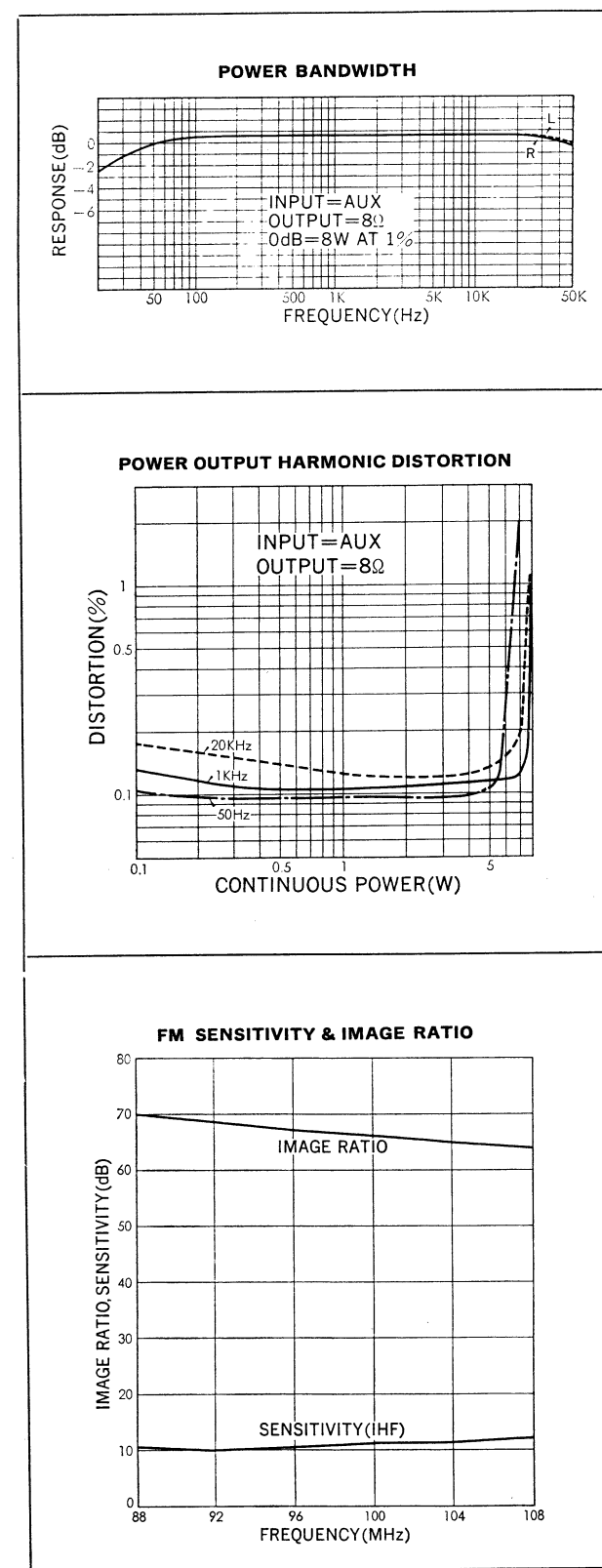

ACCESSORIES

1. OPERATING INSTRUCTIONS AND SERVICE MANUAL	1
2. OPERATING SHEET	1
3. FM ANTENNA	1
4. AM ANTENNA	1
5. PIN-PLUGS	4
6. QUICK ACTING FUSES (1.5A)	2
7. BUTTERFLY BOLTS	2
8. WASHERS	2

SCHEMATIC DIAGRAM

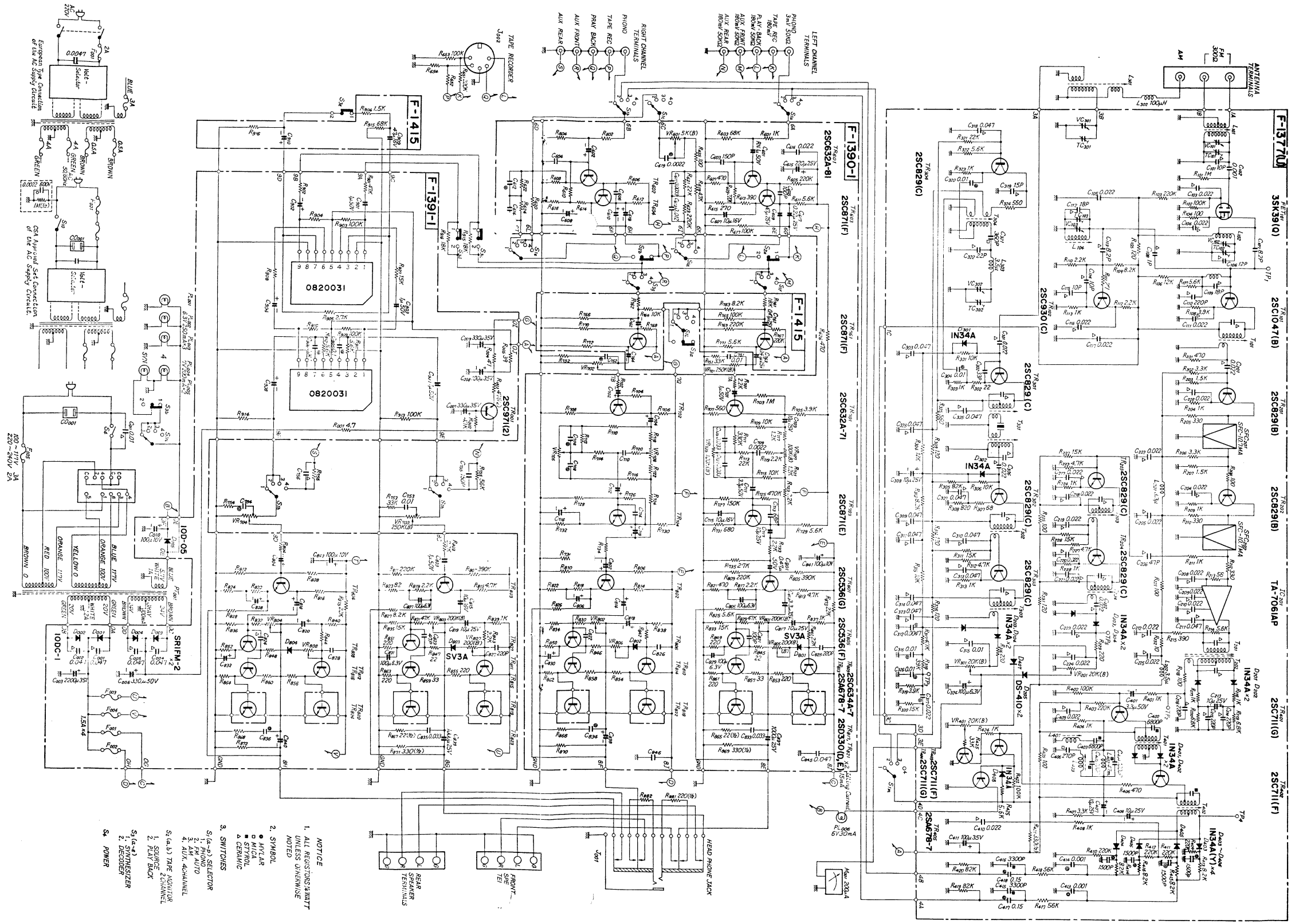

W	X	Y	Z
C116	0.022 μ F	0656223	1 C
C117	0.022 μ F	0656223	1 C
C201	0.022 μ F	0656223	1 C
C202	0.022 μ F	0656223	1 C
C203	0.022 μ F	0656223	1 B
C204	0.022 μ F	0656223	1 B
C205	0.022 μ F	0656223	1 B
C206	47 pF	0660470	2 B
C208	0.022 μ F	0656223	1 B
C209	0.022 μ F	0656223	1 B
C210	0.022 μ F	0656223	1 B
C211	0.047 μ F	0656473	1 B
C212	0.022 μ F	0656223	1 B
C213	10 μ F	0513100	1 A
C214	220 pF	0660221	1 A
C215	220 pF	0660221	1 A
C216	220 pF	0660221	1 A
C217	0.022 μ F	0656223	2 B
C218	0.022 μ F	0656223	2 B
C219	0.022 μ F	0656223	2 B
C220	0.022 μ F	0656223	2 B
C221	0.022 μ F	0656223	2 B
C222	0.022 μ F	0656223	2 B
C223	0.022 μ F	0656223	2 B
C224	0.022 μ F	0656223	2 A
C225	0.022 μ F	0656223	1 A
C301	0.022 μ F	0656223	2 C
C302	33 pF	0660330	1 C
C303	0.047 μ F	0656473	2 C
C304	0.01 μ F	0601107	2 C
C305	0.047 μ F	0656473	2 B
C306	0.022 μ F	0656223	1 B
C307	0.047 μ F	0656473	1 B
C308	10 μ F	0513100	2 B
C309	0.047 μ F	0656473	2 B
C310	0.047 μ F	0656473	1 B
C311	0.047 μ F	0656473	2 B
C312	0.0047 μ F	0601476	2 A
C313	0.047 μ F	0656473	1 B
C314	0.047 μ F	0656473	2 B
C315	0.01 μ F	0659103	2 A
C316	0.01 μ F	0601107	1 A
C317	0.022 μ F	0601227	2 A
C318	0.047 μ F	0656473	2 C
C319	15 pF	0660150	2 C
C320	0.01 μ F	0601107	2 B, C
C321	360 pF	0620361	2 B
C322	22 pF	0660220	2 B
C323	0.047 μ F	0656473	2 A, B
C324	100 μ F	0511101	2 A
C325	0.047 μ F	0656473	2 B
C326	0.01 μ F	0601107	1 A
C401	3.3 μ F	0515339	1 A
C402	6800 pF	0620682	1 A
C403	6800 pF	0620682	1 A

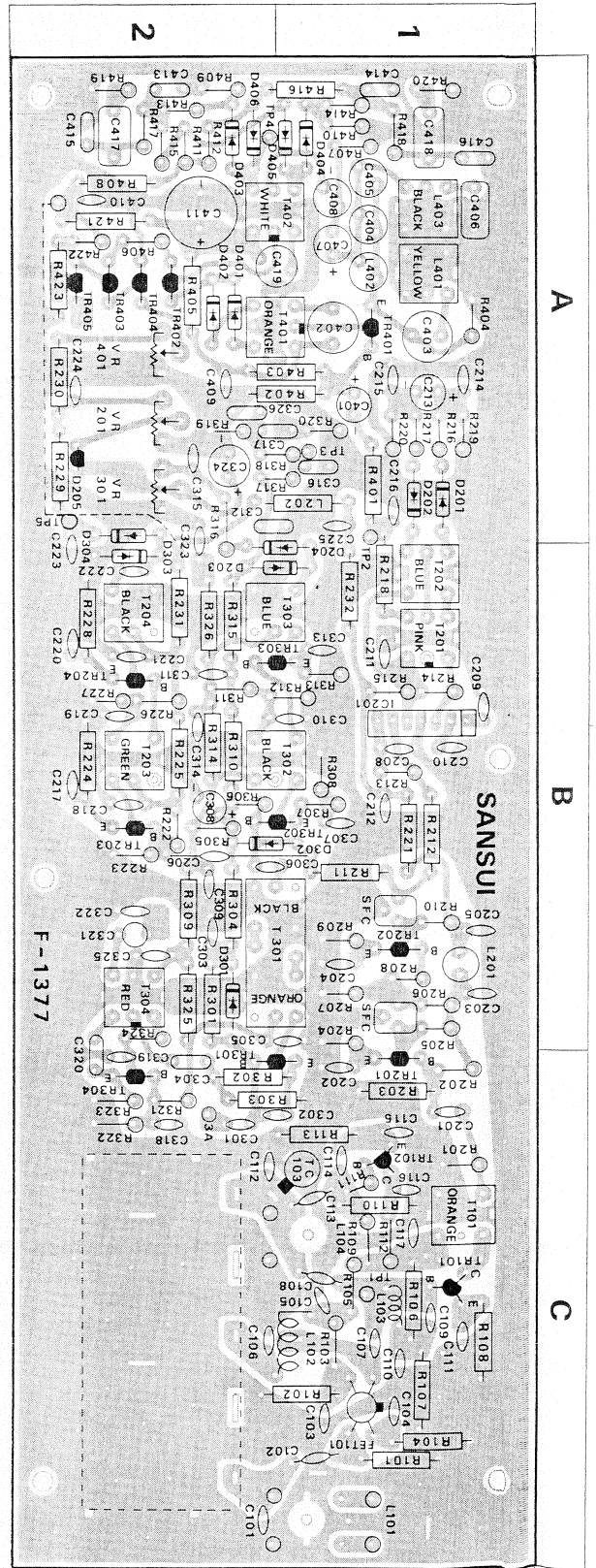

GENERAL TROUBLESHOOTING CHART

If the receiver is otherwise operating satisfactorily, the more common causes of trouble may generally be attributed to the following:

1. Incorrect connections or loose terminal contacts. Check the speakers, record player tape deck, antenna and power cord.
2. Improper operation. Before operating any audio com-

ponent, be sure to read its manufacturer's instructions.

3. Improper location of audio components. The proper positioning of components, such as speakers and record player is essential to the maximum stereo enjoyment.

4. Defective audio components.

The following are more other common causes of malfunction and what to do about them.

PROGRAM	SYMPTOM	PROBABLE CAUSE	WHAT TO DO
AM, FM or MPX reception	A. Constant or intermittent noise heard at times or in certain areas	<ul style="list-style-type: none"> * Discharge or oscillation caused by electrical appliances, such as fluorescent lamp, D.C. motor, or rectifier * Insufficient antenna input due to ferroconcrete wall or long distance from station 	<ul style="list-style-type: none"> * Attach noise limiter to electrical appliance producing noise, or attach it to the receiver's power source * Reverse power cord plug/receptacle connections * Keep receiver at proper distance from other electrical appliances * Install antenna for maximum antenna efficiency. See "ANTENNA" in operating instructions
FM, or FM MPX reception	A. Noisy	<ul style="list-style-type: none"> * Poor noise limiter effect or too low S/N ratio due to insufficient antenna input <p>Note: FM reception is affected considerably by transmission conditions of station, such as power and antenna efficiency. As a result, you may receive one station quite well while receiving another station poorly.</p>	<ul style="list-style-type: none"> * Install dipole antenna (supplied) for maximum signal strength * If this does not prove effective, use exclusive FM outdoor antenna * Excessively long antenna may cause noise
	B. A series of pops	<ul style="list-style-type: none"> * Ignition noise caused by starting of nearby automobile engine 	<ul style="list-style-type: none"> * Install antenna and its lead-in wire at proper distance from street or increase antenna input as described before
	C. Channel separation deteriorates during reception	<ul style="list-style-type: none"> * Excess heat 	<ul style="list-style-type: none"> * Circulation of room air is important to receiver. Be sure that receiver is well ventilated
Record playing or tape playback	A. Hum or howling	<ul style="list-style-type: none"> * Record player placed directly on speaker * Wire other than shielded cable used * Loose terminal contact 	<ul style="list-style-type: none"> * Place cushion between record player and speaker cabinet or place them away from each other * Connecting shielded cable should be as short as possible
	B. Surface noise	<ul style="list-style-type: none"> * Worn or old record * Worn phono stylus * Phono stylus is dusty * Improper stylus pressure 	<ul style="list-style-type: none"> * Recondition playback head of tape deck or the stylus of record player * Turn TREBLE control counter-clockwise
4-Channel stereo playback	A. Position of musical instruments and voice not clear	<ul style="list-style-type: none"> * Incorrect phasing of speakers or input connections 	<ul style="list-style-type: none"> * Check phasing of speakers and input connections * The rear speakers should be changed in position and direction

PRINTED CIRCUIT BOARDS AND PARTS LIST

W: Parts No. X: Parts Name Y: Stock No. Z: Position of Parts

TUNER BLOCK <F-1377U>

W	X	Y	Z	W	X	Y	Z
R101	1M Ω	0101105	1C	R314	120 Ω	0101121	2B
R102	100k Ω	0101104	1C	R315	10k Ω	0101103	2B
R103	220k Ω	0100224	1C	R316	220 Ω	0100221	2B
R104	100 Ω	0101101	1C	R317	4.7k Ω	0100472	1A
R105	120 Ω	0100121	1C	R318	39k Ω	0100393	1A
R106	12k Ω	0101123	1C	R319	3.9k Ω	0100392	2A
R107	5.6k Ω	0101562	1C	R320	15k Ω	0100153	1A
R108	3.9k Ω	0101392	1C	R321	22k Ω	0100223	2C
R109	8.2k Ω	0100822	1C	R322	5.6k Ω	0100562	2C
R110	2.2k Ω	0101222	1C	R323	1k Ω	0100102	2C
R111	27 Ω	0100270	1C	R324	560 Ω	0100561	2B
R112	2.2k Ω	0100222	1C	R325	560 Ω	0101561	2B
R113	1k Ω	0101102	1C	R326	120 Ω	0101121	2B
R201	470 Ω	0100471	1C	R401	1k Ω	0101102	1A
R202	3.3k Ω	0100332	1C	R402	100k Ω	0101104	1, 2A
R203	1.5k Ω	0101152	1C	R403	220k Ω	0101224	1, 2A
R204	1k Ω	0100102	1B	R404	1k Ω	0100102	1A
R205	330 Ω	0100331	1B	R405	100 Ω	0101101	2A
R206	3.3k Ω	0100332	1B	R406	470 Ω	0100471	2A
R207	1.5k Ω	0100152	1B	R407	3.3k Ω	0100332	1A
R208	100 Ω	0100101	1B	R408	1k Ω	0101102	2A
R209	1k Ω	0100102	1B	R409	220k Ω	0100224	2A
R210	330 Ω	0100331	1B	R410	220k Ω	0100224	1A
R211	1k Ω	0101102	1B	R411	220k Ω	0100224	2A
R212	330 Ω	0101331	1B	R412	220k Ω	0100224	2A
R213	56 Ω	0100560	1B	R413	8.2k Ω	0100822	2A
R214	5.6k Ω	0100562	1B	R414	8.2k Ω	0100822	1A
R215	390 Ω	0100391	1B	R415	8.2k Ω	0100822	2A
R216	1k Ω	0100102	1A	R416	8.2k Ω	0101822	1, 2A
R217	1k Ω	0100102	1A	R417	56k Ω	0100563	2A
R218	100 Ω	0101101	1B	R418	56k Ω	0100563	1A
R219	6.8k Ω	0100682	1A	R419	82k Ω	0100823	2A
R220	6.8k Ω	0100682	1A	R420	82k Ω	0100823	1A
R221	100 Ω	0101101	1B	R421	330 Ω	0111331	2A
R222	15k Ω	0100153	2B	R422	10k Ω	0101104	2A
R223	4.7k Ω	0100472	2B	R424	1k Ω	0101472	2A
R224	1k Ω	0101102	2B	R425	5.6k Ω	0101562	2A
R225	100 Ω	0101101	2B	VR201	20k Ω (B) FM Meter Adj.	1032122	2A
R226	15k Ω	0100153	2B	VR301	20k Ω (B) AM Meter Adj.	1032122	2A
R227	4.7k Ω	0100472	2B	VR401	20k Ω (B) Stereo Indicator Adj.	1032122	2A
R228	1k Ω	0101102	2B	C101	10pF	0664100	2C
R229	220 Ω	0101221	2A	C102	0.001 μ F	0654102	1C
R231	120 Ω	0101121	2B	C103	0.022 μ F	0656223	1C
R232	10 Ω	0101100	1B	C104	0.022 μ F	0656223	1C
R301	10k Ω	0101103	2B	C105	0.022 μ F	0656223	1C
R302	22 Ω	0101220	2C	C106	12pF	0661120	2C
R303	1k Ω	0101102	2C	C107	8.2pF	0661829	1C
R304	12k Ω	0101123	2B	C108	1pF	0661109	1C
R305	82k Ω	0100823	2B	C109	18pF	0661180	1C
R306	10k Ω	0100103	2B	C110	220pF	0660221	1C
R307	68 Ω	0100680	1B	C111	0.022 μ F	0656223	1C
R308	820 Ω	0100821	1B	C112	18pF	0669019	2C
R309	120 Ω	0101121	2B	C113	8.2pF	0669015	1C
R310	8.2k Ω	0101822	2B	C114	10pF	0664100	1C
R311	15k Ω	0100153	2B	C115	10pF	0664100	1C
R312	4.7k Ω	0100472	1B				
R313	1k Ω	0100102	1B				

PRINTED CIRCUIT BOARDS AND PARTS LIST

W: Parts No. X: Parts Name Y: Stock No. Z: Position of Parts

TUNER BLOCK <F-1377U> Continued

W	X	Y	Z
C404	1000 pF	± 5 % 50 V SC.	0620102 1 A
C405	100 pF		0620101 1 A
C406	270 pF	± 5 % 50 V MiC.	0640271 1 A
C407	10 μF	25 V EC.	0513100 1 A
C408	10 μF		0513100 1 A
C409	0.022 μF	+80% -20% 25 V CC.	0656223 2 A
C410	0.022 μF		0656223 2 A
C411	100 μF	35 V EC.	0514101 2 A
C413	0.001 μF	± 10% 50 V MC.	0601106 2 A
C414	0.001 μF		0601106 1 A
C415	3300 pF	± 5 % 50 V SC.	0620332 2 A
C416	3300 pF		0620332 1 A
C417	0.15 μF	± 10% 50 V MC.	0601158 2 A
C418	0.15 μF		0601158 1 A
C419	2700 pF	± 5 % 50 V SC.	0620272 1, 2 A
VC101~103	Variable Capacitor	1220090	
FET101	3SK39 (Q)	0370080	1 C
TR101	2SC1047 (B)	0305800	1 C
TR102	2SC930 (C)	0305790	1 C
TR201	2SC829 (B)	0305460	1 C
TR202		0305460 1 B	
TR203		0305461 2 B	
TR204		0305461 2 B	
TR301	2SC829 (C)	0305461	2 C
TR302		0305461 1 B	
TR303		0305461 1, 2 B	
TR304		0305461 2 C	
TR401	2SC711 (G)	0305733	1 A
TR402	2SC711 (F)	0305732	2 A
TR403		0305732 2 A	
TR404	2SC711 (G)	0305733	2 A
TR405	2SA678-7	0300292	2 A
IC201	TA-7061AP	0360060	1 B
D201	IN34A	0310400	1 A
D202		0310400 1 A	
D203		0310400 2 B	
D204		0310400 1 B	
D205	DS430	0340090	2 A
D301		0310400 2 B	
D302		0310400 1 B	
D303	IN34A	0310400	2 B
D304		0310400 2 B	
D401		0310400 2 A	
D402		0310400 2 A	
D403		0310401 2 A	
D404	IN34A (Y)	0310401	1 A
D405		0310401 2 A	
D406		0310401 2 A	
D408	IN34A	0310400	2 A
T101	FM IFT	4235790	1 C
T201	FM Discriminator	4235750	1 B
T202		4235760 1 B	

W	X	Y	Z
T203	FM Meter Coil	4235770	2 B
T204		4235780 2 B	
T301	CFU-73B Ceramic Filter	4230550	1, 2 B
T302	AM IFT	4230510	1, 2 B
T303		4230500 1, 2 B	
T304	AM OSC Coil	4220280	2 B
T401	MPX Coil	4240630	1, 2 A
T402		4240620 1, 2 A	
L101	FM Antenna Coil	4200370	1 C
L102	FM RF Coil	4210090	1 C
L103	Choke Coil	4290110	1 C
L104	FM OSC Coil	4220270	1 A
L201	Peaking Coil	4900030	1 B
L202		4290011 1, 2 A	
L303		4290011	
L401	MPX Coil	4240640	1 A
L402	Ferri Inductor	4900030	1 A
L403	MPX Coil	4240610	1 A
SFC201	SFC-10.7MA Ceramic Filter	0910120	1 B
SFC202	SFC-10.7MA Ceramic Filter	0910120	1 B

FRONT CHANNEL BLOCK <F-1390-1>

W	X	Y	Z
R601	1kΩ	0101102	1 A
R602	1kΩ	0101102	2 A
R603	68kΩ	0101683	1 A
R604	68kΩ	0101683	2 A
R605	220kΩ	0101224	2 A
R606	220kΩ	0101224	2 A
R607	470Ω	0101471	1 A
R608	470Ω	0101471	2 A
R609	220kΩ	0101224	1 A
R610	220kΩ	0101224	2 A
R611	5.6kΩ	0101562	1 A
R612	5.6kΩ	0101562	2 A
R613	390Ω	0101391	1 A
R614	390Ω	0101391	2 A
R615	270Ω	0101271	1 A
R616	270Ω	0101271	2 A
R617	100kΩ	0101104	1 A
R618	100kΩ	0101104	2 A
R619	4.7kΩ	0101472	1 A
R620	4.7kΩ	0101472	2 A
R621	22kΩ	0101223	1 A
R622	22kΩ	0101223	2 A
R623	220kΩ	0101224	1 A
R624	220kΩ	0101224	2 A
R625	100Ω	0101101	2 A
R626	470Ω	0101471	2 A, B
R701	2.2kΩ	0101222	1 A
R702	2.2kΩ	0101222	2 A
R703	1MΩ	0101105	1 A
R704	1MΩ	0101105	2 A, B
R705	3.9kΩ	0101392	1 A
R706	3.9kΩ	0101392	2 A, B
R707	560Ω	0101561	1 A
R708	560Ω	0101561	2 A
R709	10kΩ	0101103	1 B
R710	10kΩ	0101103	2 B
R711	330kΩ	0101334	1 B
R712	330kΩ	0101334	2 B
R713	22kΩ	0101223	1 B
R714	22kΩ	0101223	2 B
R715	10kΩ	0101103	1 B
R716	10kΩ	0101103	2 B
R717	1.2kΩ	0101122	1 A
R718	1.2kΩ	0101122	2 A
R719	2.2kΩ	0101222	1 B
R720	2.2kΩ	0101222	2 B
R721	1.2kΩ	0101122	1 B
R722	1.2kΩ	0101122	2 B
R723	2.2kΩ	0101222	1 B
R724	2.2kΩ	0101222	2 B
R725	470kΩ	0101474	1 B
R726	470kΩ	0101474	2 B
R727	150kΩ	0101154	1 B
R728	150kΩ	0101154	2 B
R729	5.6kΩ	0101562	1 B
R730	5.6kΩ	0101562	2 B
R731	680Ω	0101681	1 B

±10% ¼W CR.

W	X	Y	Z	
R732	680Ω	0101681	2 B	
R733	2.2kΩ	0101222	1 B	
R734	2.2kΩ	0101222	2 B	
R735	27kΩ	0101273	1 B	
R736	27kΩ	0101273	2 B	
R805	390kΩ	0101394	1 B	
R806	390kΩ	0101394	2 B	
R809	220kΩ	0101224	1 B	
R810	220kΩ	0101224	2 B	
R813	4.7kΩ	0101472	1 B	
R814	4.7kΩ	0101472	2 B	
R817	2.2kΩ	0101222	1 B	
R818	2.2kΩ	0101222	2 B	
R821	470Ω	0101471	1 B	
R822	470Ω	0101471	2 B	
R825	5.6kΩ	0101562	1 B	
R826	5.6kΩ	0101562	2 B	
R829	47kΩ	0101473	1 C	
R830	47kΩ	0101473	2 C	
R833	15kΩ	0101153	1 B	
R834	15kΩ	0101153	2 B	
R837	1kΩ	0101102	1 C	
R838	1kΩ	0101102	2 C	
R841	2.2kΩ	0101222	1 C	
R842	2.2kΩ	0101222	2 C	
R845	22Ω	0101220	1 C	
R846	22Ω	0101220	2 C	
R849	220Ω	0101221	1 C	
R850	220Ω	0101221	2 C	
R853	220Ω	0101221	1 C	
R854	220Ω	0101221	2 C	
R857	33Ω	0101330	1 C	
R858	33Ω	0101330	2 C	
R861	220Ω	0101221	1 C	
R862	220Ω	0101221	1 C	
R865	22Ω	0111220	1 C	
R866	22Ω	0111220	2 C	
R869	330Ω	0111331	1 C	
R870	330Ω	0111331	2 C	
R873	22kΩ	0101223	2 C	
VR601	5kΩ (B) FM Stereo Separation Adj.	1031092	2 A	
VR801	200kΩ (B) AC Balance Adj.	1031152	1 C	
VR802		1031152	1 C	
VR805	200Ω (B) DC Bias Adj.	1031022	2 C	
VR806		1031022	1 C	
C601	1μF	RN 50 V EC.	0519101	1 A
C602	1μF		0519101	2 A
C603	150pF	±10% 50 V CC.	0660151	1 A
C604	150pF		0660151	2 A
C605	100pF		0660101	1 A
C606	100pF		0660101	2 A
C607	10μF	16 V EC.	0512100	1 A
C608	10μF		0512100	2 A

±10% ¼W CR.

±10% ½W SR.

±10% ¼W CR.

PRINTED CIRCUIT BOARDS AND PARTS LIST

W: Parts No. X: Parts Name Y: Stock No. Z: Position of Parts

FRONT CHANNEL BLOCK <F-1390-1> continued

W	X	Y	Z	W	X	Y	Z
C609	4.7 μ F	25 V EC.	0513479	1A	2SC536 (G)	0305156	1 B
C610	4.7 μ F		0513479	2A		0305156	2 B
C611	0.0033 μ F	$\pm 10\%$ 50 V MC.	0601336	1A	2SC536 (F)	0305155	1 B, C
C612	0.0033 μ F		0601336	2A		0305155	2 B, C
C613	0.012 μ F		0601127	1A	2SC634A (6, 7)	0305891, 2	1 C
C614	0.012 μ F		0601127	2A		0305891, 2	2 C
C615	220 μ F	25 V EC.	0513221	1A	2SA678 (6, 7)	0300291, 2	1 C
C616	0.022 μ F	$\pm 80\%$ 25 V CC.	0656223	1A		0300291, 2	2 C
C617	0.22 μ F	25 V AEC.	0563228	1A			
C618	0.22 μ F		0563228	2A			
C619	0.0022 μ F	$\pm 10\%$ 50 V MC.	0601226	2A			
C703	10 μ F	25 V EC.	0513100	1 B			
C704	10 μ F		0513100	2 B			
C705	0.033 μ F	$\pm 10\%$ 50 V MC.	0601337	1 B			
C706	0.033 μ F		0601337	2 B			
C707	0.033 μ F		0601337	1 B			
C708	0.033 μ F		0601337	2 B			
C709	0.0022 μ F		0601226	1 B			
C710	0.0022 μ F		0601226	2 B			
C711	3.3 μ F	50 V EC.	0515339	1 B			
C712	3.3 μ F		0515339	2 B			
C713	68 pF	$\pm 10\%$ 50 V CC.	0660680	1 B			
C714	68 pF		0660680	2 B			
C715	10 μ F	16 V EC.	0512100	1 B			
C716	10 μ F		0512100	2 B			
C717	10 μ F	25 V EC.	0513100	1 B			
C718	10 μ F		0513100	2 B			
C801	0.47 μ F	50 V EC.	0515478	1 B			
C802	0.47 μ F		0515478	2 B			
C805	100 μ F	6.3 V EC.	0510101	1 B			
C806	100 μ F		0510101	2 B			
C813	3.3 μ F	35 V EC.	0514339	1 B			
C814	3.3 μ F		0514339	2 B			
C817	10 μ F	25 V EC.	0513100	1 B			
C818	10 μ F		0513100	2 B			
C821	100 pF	$\pm 10\%$ 50 V CC.	0660101	1 B			
C822	100 pF		0660101	2 B			
C825	220 pF		0660221	1 C			
C826	220 pF		0660221	2 C			
C829	100 μ F		6.3 V EC.	0510101	1 B		
C830	100 μ F			0510101	2 B		
C833	0.033 μ F	$\pm 10\%$ 50 V MC.	0601337	1 C			
C834	0.033 μ F		0601337	2 C			
C837	1000 μ F	25 V EC.	0513102	1 C			
C838	1000 μ F		0513102	2 C			
C841	100 μ F	10 V EC.	0511101	2 B			
C845	0.047 μ F	$\pm 80\%$ 50 V CC.	0657473	1 C			
C846	0.047 μ F		0657473	2 C			
TR601	2SC632A-81		0305762	1 A			
TR602			0305762	2 A			
TR603	2SC871 (F)		0305472	1 A			
TR604			0305472	2 A			
TR701	2SC632A-7 (white)		0305766	1 A			
TR702			0305766	2 A			
TR703	2SC871 (E)		0305471	1 B			
TR704			0305471	2 B			

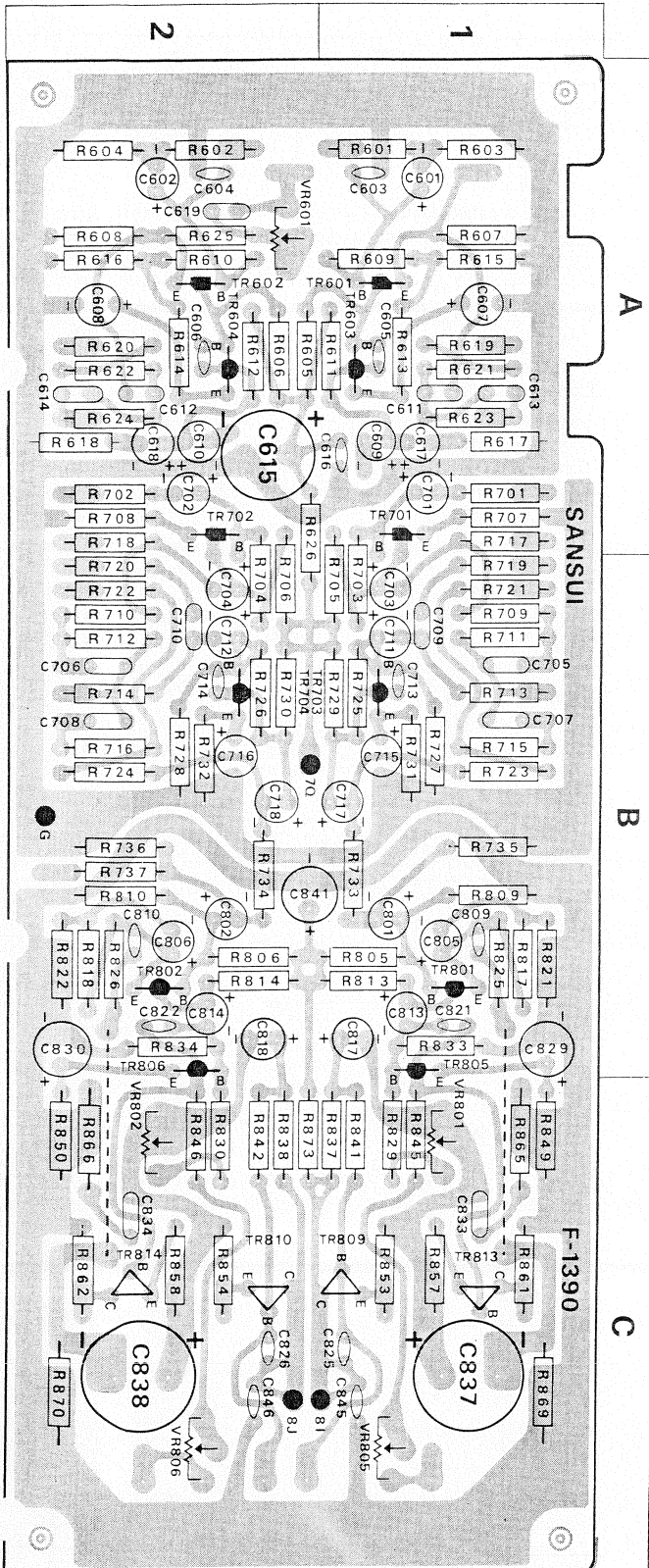

BLEND BLOCK <F-1415>

W	X	Y	Z
R761	18kΩ	±10% ¼W CR.	0101183 1 A
R762	18kΩ		0101183 1 A
R763	8.2kΩ		0101822 1 A
R764	10kΩ		0101103 2 A
R765	100kΩ		0101104 1 A
R766	100kΩ		0101104 2 A
R767	220kΩ		0101224 1 B
R768	220kΩ		0101224 2 B
R769	220kΩ		0101224 1 B
R770	220kΩ		0101224 2 B
R771	5.6kΩ	0101562 1 B	
R772	5.6kΩ	0101562 1 B	
R906	1.5kΩ	0101152 2 A	
R915	68kΩ	0101683 2 A	
R916	68kΩ	0101683 2 A	
C761	0.47μF	25 V AEC.	0563478 1 A
C762	0.47μF		0563478 2 A
C763	0.47μF		0563478 1 A
C764	0.47μF	16 V EC.	0563478 1 A
C909	47μF		0512470 2 A
C910	47μF		0512470 2 A
TR761	2SC871 (F)		0305472 1 B
TR762	2SC871 (F)	0305472 2 B	

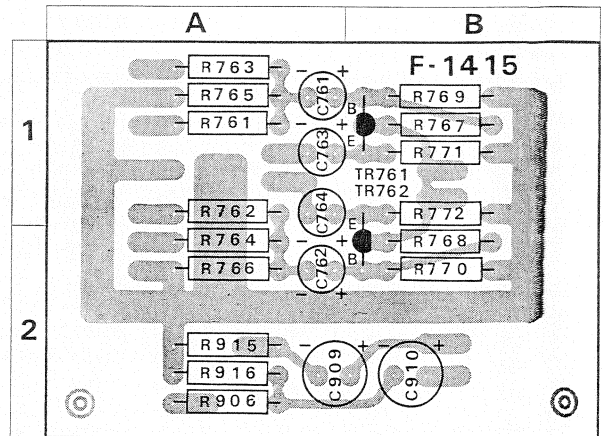

PRINTED CIRCUIT BOARDS AND PARTS LIST

W: Parts No. X: Parts Name Y: Stock No. Z: Position of Parts

REAR CHANNEL, POWER BLOCK <F-1391-1>

W	X	Y	Z	W	X	Y	Z				
R001	4.7Ω	±10% ¼W CR.	0101479	1C	VR804	200kΩ (B) AC Balance Adj.	1031152	2B			
R002	4.7kΩ		0101472	1, 2C	VR807	200Ω (B) DC Bias Adj.	1031022	2B			
R003	47Ω	±10% ½W SR.	0111470	1C	VR808		1031022	2B			
R004	47Ω		0111470	1C							
R005	56Ω		0101560	1, 2C	C001	0.047μF	+80%	50 V CC.	0657473	2A	
R803	2.2kΩ		0101222	1C	C002	0.047μF	-20%		0657473	2A	
R804	2.2kΩ		0101222	2C	C003	2200μF		35 V EC.	0549005	2A	
R807	390kΩ		0101394	1C	C004	0.047μF	+80%	50 V CC.	0657473	2A	
R808	390kΩ		0101394	2C	C005	0.047μF	-20%		0657473	2A	
R811	220kΩ		0101224	1C	C006	330μF		50 V EC.	0515331	2A	
R812	220kΩ		0101224	2C	C007	330μF			0514331	2C	
R815	4.7kΩ		0101472	1C	C008	100μF		35 V EC.	0514101	1C	
R816	4.7kΩ		0101472	2C	C009	330μF			0514331	2C	
R819	2.2kΩ		0101222	1C	C010	100μF		10 V EC.	0511101	2A	
R820	2.2kΩ		0101222	2C	C803	1μF		50 V EC.	0515109	1C	
R823	82Ω		0101820	1C	C804	1μF			0515109	2C	
R824	82Ω		0101820	2C	C807	100μF		6.3 V EC.	0510101	1C	
R827	8.2kΩ		0101822	1C	C808	100μF			0510101	2C	
R828	8.2kΩ		0101822	2C	C811	100pF			0660101	1C	
R831	47kΩ	±10% ¼W CR.	0101473	1B	C812	100pF		±10%	50 V CC.	0660101	2C
R832	47kΩ			0101473	2B	C815	10μF			0512100	1B, C
R835	15kΩ		0101153	1B	C816	10μF		16 V EC.	0512100	2B, C	
R836	15kΩ		0101153	2B	C819	10μF		25 V EC.	0513100	1B	
R839	1kΩ		0101102	1B	C820	10μF			0513100	2B	
R840	1kΩ		0101102	2B	C823	47pF			0660470	1B	
R843	2.2kΩ		0101222	1B	C824	47pF			0660470	2B	
R844	2.2kΩ		0101222	2B	C827	220pF		±10%	50 V CC.	0660221	1B
R847	22Ω		0101220	1B	C828	220pF			0660221	2B	
R848	22Ω		0101220	2B	C831	100μF		6.3 V EC.	0510101	1B	
R851	220Ω		0101221	1B	C832	100μF			0510101	2B	
R852	220Ω		0101221	2B	C835	0.033μF			0601337	1B	
R855	220Ω		0101221	1B	C836	0.033μF		±10%	50 V MC.	0601337	2B
R856	220Ω		0101221	2B	C839	1000μF			0513102	1B	
R859	33Ω		0101330	1B	C840	1000μF		25 V EC.	0513102	2B	
R860	33Ω		0101330	2B	C843	100μF		10 V EC.	0511101	1, 2C	
R863	220Ω		0101221	1B	C901	1μF			0515109	1C	
R864	220Ω		0101221	2B	C902	1μF		50 V EC.	0515109	2C	
R867	22Ω		0111220	2B	C903	1μF			0515109	1C	
R868	22Ω		0111220	1B	C904	1μF			0515109	2C	
R871	330Ω	±10% ½W SR.	0111331	2B	C905	0.1μF			0601108	1C	
R872	330Ω			0111331	1B	C906	0.047μF		±10%	50 V MC.	0601477
R875	22kΩ	±10% ½W CR.	0101223	2B	C907	1μF			0515109	1C	
R901	47kΩ			0101473	1C	C908	1μF		50 V EC.	0515109	2C
R902	47kΩ		0101473	2C							
R903	100kΩ		0101104	1C	TR001	2SC971 (2)			0305530	1, 2C	
R904	100kΩ		0101104	2C	TR803	2SC536 (G)			0305156	1C	
R905	2.7kΩ		0101272	1, 2C	TR804				0305156	2C	
R907	15kΩ		0101153	1C	TR807		2SC536 (F)			0305155	1B
R908	15kΩ	±10% ¼W CR.	0101153	2C	TR808				0305155	2B	
R909	100kΩ			0101104	1C	TR811	2SC634A (6, 7)			0305891, 2	1A
R910	100kΩ		0101104	2C	TR812				0305891, 2	2A	
R911	5.6kΩ		0101562	1C	TR815	2SA678 (6, 7)			0300291, 2	1A	
R912	5.6kΩ		0101562	2C	TR816				0300291, 2	2B	
R913	100kΩ		0101104	1C							
R914	100kΩ		0101104	2C							
VR803	200kΩ (B) AC Balance Adj.		1031152	1B	IC901	Hybrid IC			0820031	1, 2C	
					IC902				0820031	1, 2C	

W	X	Y	Z	
D001	10DC1	0310680	2 A	
D002		0310680	2 A	
D003		SR1FM2	0310870	2 A
D004			0310870	2 A
D005		10D05	0310880	2 A
F001	Front Left	Quick Acting Fuse (1.5A)	0433222	1 A
F002	Front Right		0433222	1 A
F003	Rear Left		0433222	1 A
F004	Rear Right		0433222	1 A

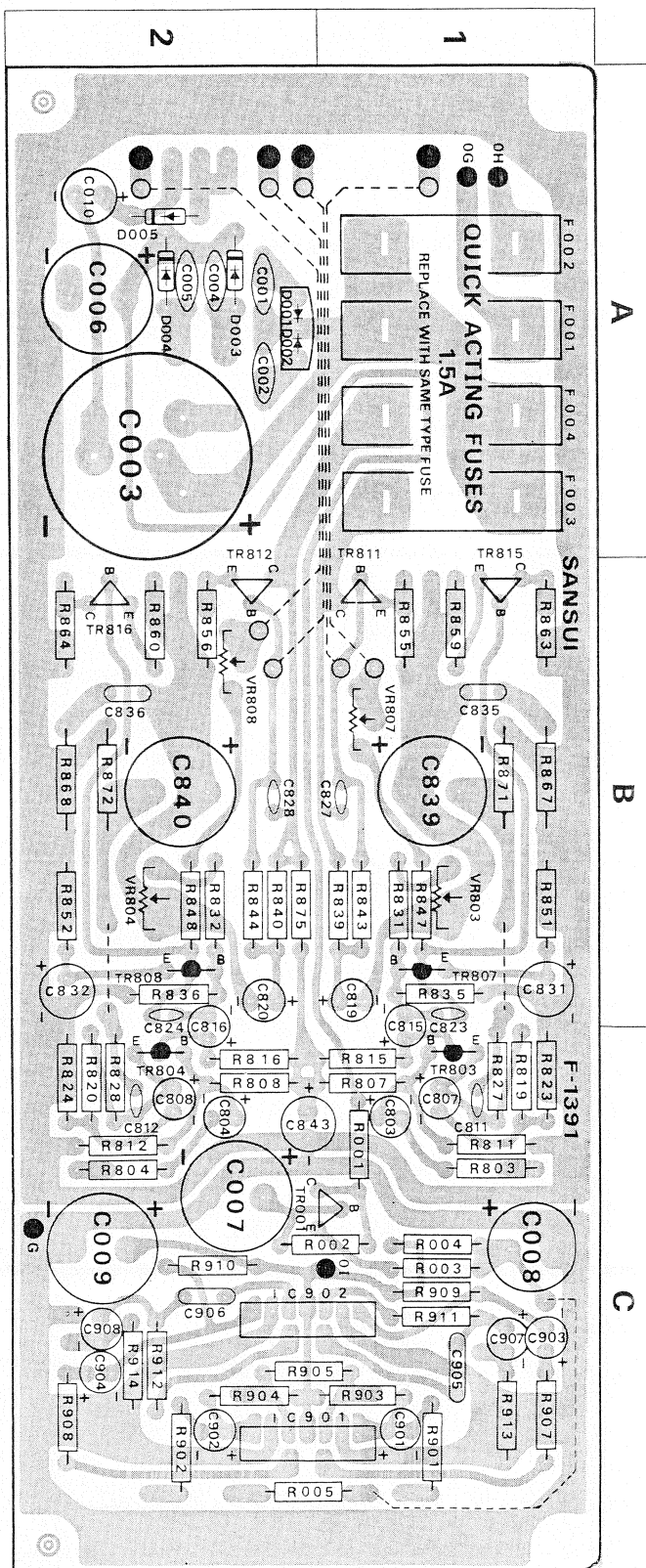

OTHER PARTS AND THEIR POSITIONS ON CHASSIS

W: Parts No. X: Parts Name Y: Stock No.

OTHER PARTS

W	X	Y	
R006	33 Ω	0101330	
R425	33k Ω	0101333	
R651	220k Ω	0101224	
R652	220k Ω	0101224	
R653	100k Ω	0101104	
R654	100k Ω	0101104	
R751	33k Ω	0101333	
R752	33k Ω	0101333	
R753	33k Ω	0101333	
R754	33k Ω	0101333	
R755	56k Ω	0101563	
R756	56k Ω	0101563	
R881	220 Ω	0111221	
R882	220 Ω	0111221	
R915	18k Ω	0101183	
R916	18k Ω	0101183	
C011	0.01 μ F	1.4kV CC.	0659801
C012	220 μ F	16 V EC.	0512221
C013	0.022 μ F	+80% -20% 50 V CC.	0657223
C701	1 μ F	50 V EC.	0515109
C702	1 μ F		0515109
C751	0.01 μ F	$\pm 10\%$ 50 V MC.	0601107
C752	0.01 μ F		0601107
C753	0.01 μ F		0601107
C754	0.01 μ F		0601107
C755	150pF		0660151
C756	150pF	$\pm 10\%$ 50 V CC.	0660151
VR701~702	250k Ω (B) $\times 2$	Front Channel Volume	1040120
VR703~704	250k Ω (B) $\times 2$	Rear Channel Volume	1040120
VR705~706	100k Ω (B) $\times 2$	Bass Control	1010760
VR707~708	100k Ω (B) $\times 2$	Treble Control	1010760
TR817~824	2SD330 (D, E)		0308361, 2
D407	DS-410		0340030
D801~804	5V3A		0340070
PT001	Power Transformer		4001050
L301	AM Bar Antenna		4200280
L302	Microinductor		4900110
M001	Tuning Meter		4300260
S1(a~p)	Selector Switch		1104190
S2(a, b)	Tape Monitor Switch		1130400
S3(a~e)	Synthesizer/Decoder Switch		1130400
S4	Power Switch		1190020
J001	Headphones Jack		2430140
J002	DIN Jack		2430040
CO001	AC Outlet		2450040
PL001	6.3V 250mA	Pilot Lamp	0420020
PL002, 003	6.3V 250mA		0420030
PL004, 005	7 V 200mA		0400153, 4
PL006	6 V 30mA	FM Stereo Indicator	0400110
PU001	Voltage Selector		2410080 2410090

Abbreviations

CR	: Carbon Resistor
SR	: Solid Resistor
CC	: Ceramic Capacitor
EC	: Electrolytic Capacitor
MC	: Mylar Capacitor
SC	: Styrol Capacitor
MIC	: Mica Capacitor
AEC	: Aluminium Solid Electrolytic Capacitor

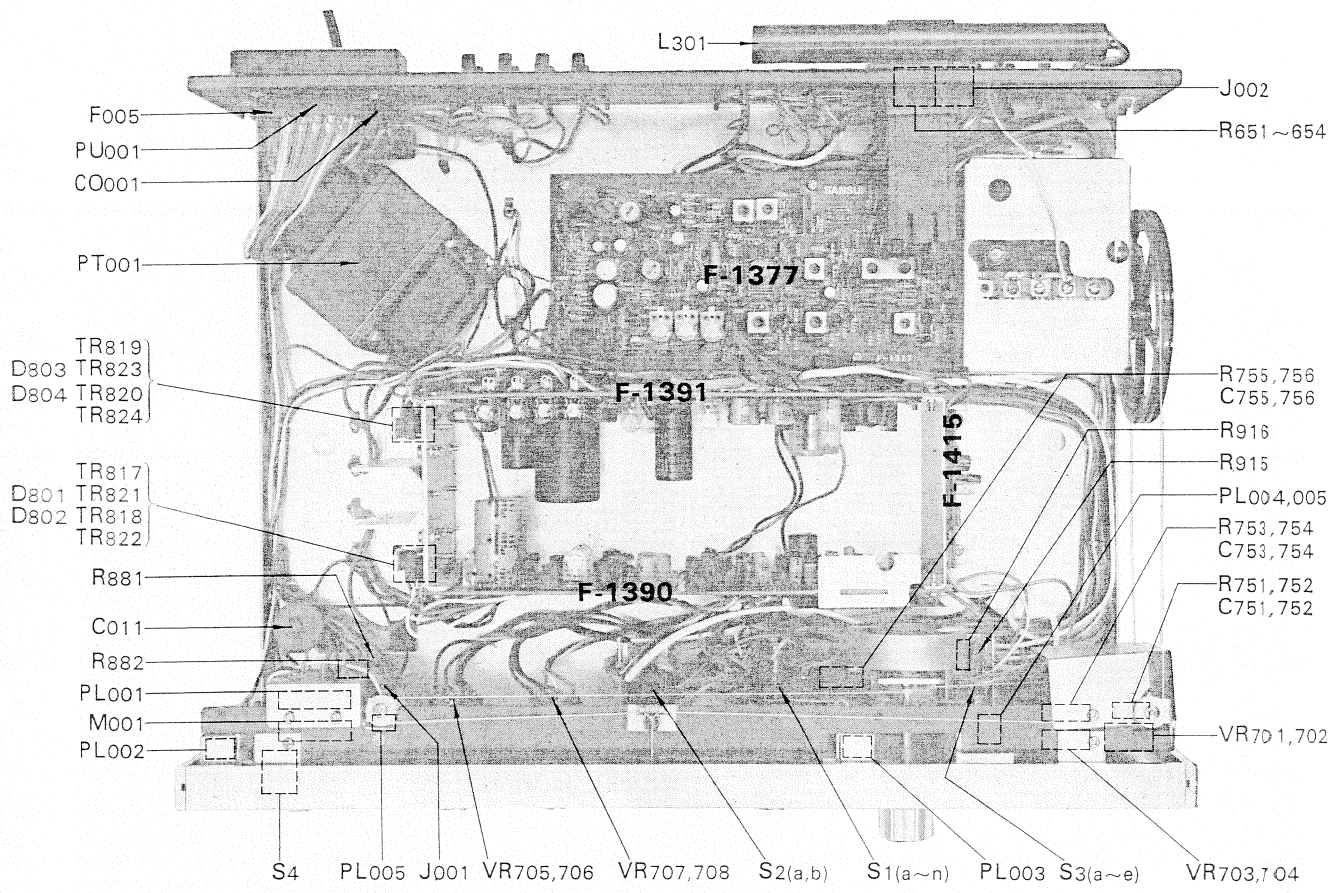



SANSUI ELECTRIC CO., LTD.
14-1, 2-chome, Izumi, Suginamiku, Tokyo 168, Japan.
TELEPHONE: (03) 323-1111 / TELEX: 232-2076

Stock No. 9206160

Printed in Japan (32920M5)